

OUTDOOR LIGHTING

LED SMART STREET LIGHT

RADAR INDUCTION, LIGHT-OPERATED, AFTER NIGHTFALL THE LIGHT TURN ON WITH WEAK LIGHT, WHEN PEOPLE APPROACHING IT TURN TO BRIGHTER FOR 15 SECONDS, IN DAYTIME THE LIGHT AUTOMATIC TURN OFF.

WATERPROOF IP65 RATING

S P E C I F I C A T I O N S H E E T





Features

- Flexible performance: light-operated + Human induction
- Intelligent: In daylight will automatic turn off. In dark night, when nobody will with weak light, when someone approaching will with strong light, wiring free, zero electric charge.
- Usage: Campus, city square, Garden, Road, village etc.
- Waterproof IP65 Rating.

Applications



Detailed description

- 1.Imported LED Chip, energy conservation and environment protection, High Color Rendering Index, low energy-consumption, Zero pollution, Long lifetime.
- 2.Poly-crystalline solar panel, Improve battery charging efficiency, Can be exposed and in the rain for a long time but will not be yellow.
- 3.Use Road photoelectric PC Lens Design, meet pavement irradiation requirements
- 4.Use Anti UV ABS+PC Shell, waterproof, anti-corrosion, effective heat radiation, longer lifetime
- 5.Radar induction, light-operated, after nightfall the light turn on with weak light, when people approaching it turn to brighter for 15 seconds, in daytime the light automatic turn off.

Product Dimension

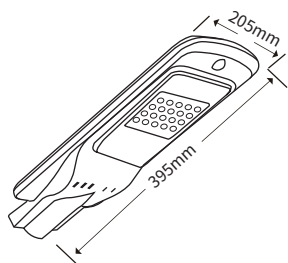

20W

MODEL NUMBER LD001-20W

Color	Color Temp
Cold White	6500K
Natural white	4000K
Warm white	3000K

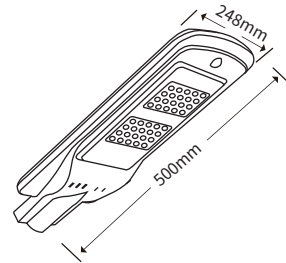

40W

MODEL NUMBER LD001-40W

Color	Color Temp
Cold White	6500K
Natural white	4000K
Warm white	3000K

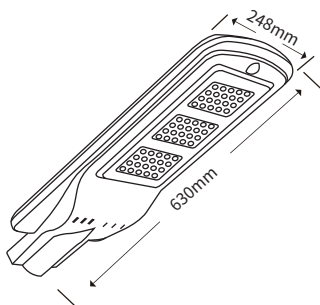

60W

MODEL NUMBER LD001-60W

Color	Color Temp
Cold White	6500K
Natural white	4000K
Warm white	3000K

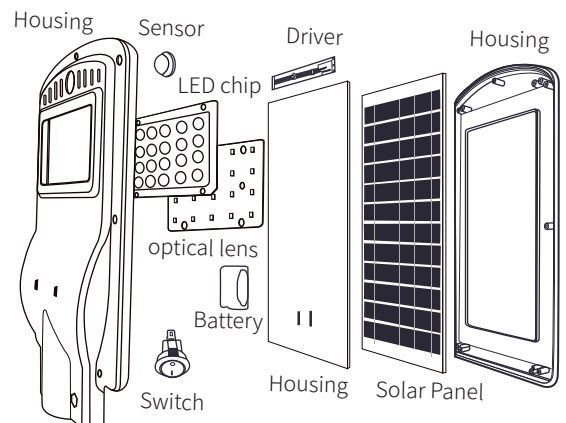

Specifications

Model number	Power	Size(mm)	Battery type	Ra	Luminous flux	Solar panel power	Installation Height	Warranty
LD001-20W	20W	395×205×55	3.2V /8000mAH	80	400lm	7W/6V	3-4m	3 Years
LD001-40W	40W	500×248×66	3.2V /10000mAH	80	800lm	10W/6V	3-5m	3 Years
LD001-60W	60W	630×248×66	3.2V /15000mAH	80	1200lm	14W/6V	3-6m	3 Years

How it works

LED SMART SOLAR STREET LIGHT
 charging in daytime
 lighting in dark night
 zero electric charge for whole year

Radar induction, light-operated, after nightfall the light turn on with weak light, when people approaching it turn to brighter for 15 seconds, in daytime the light automatic turn off.

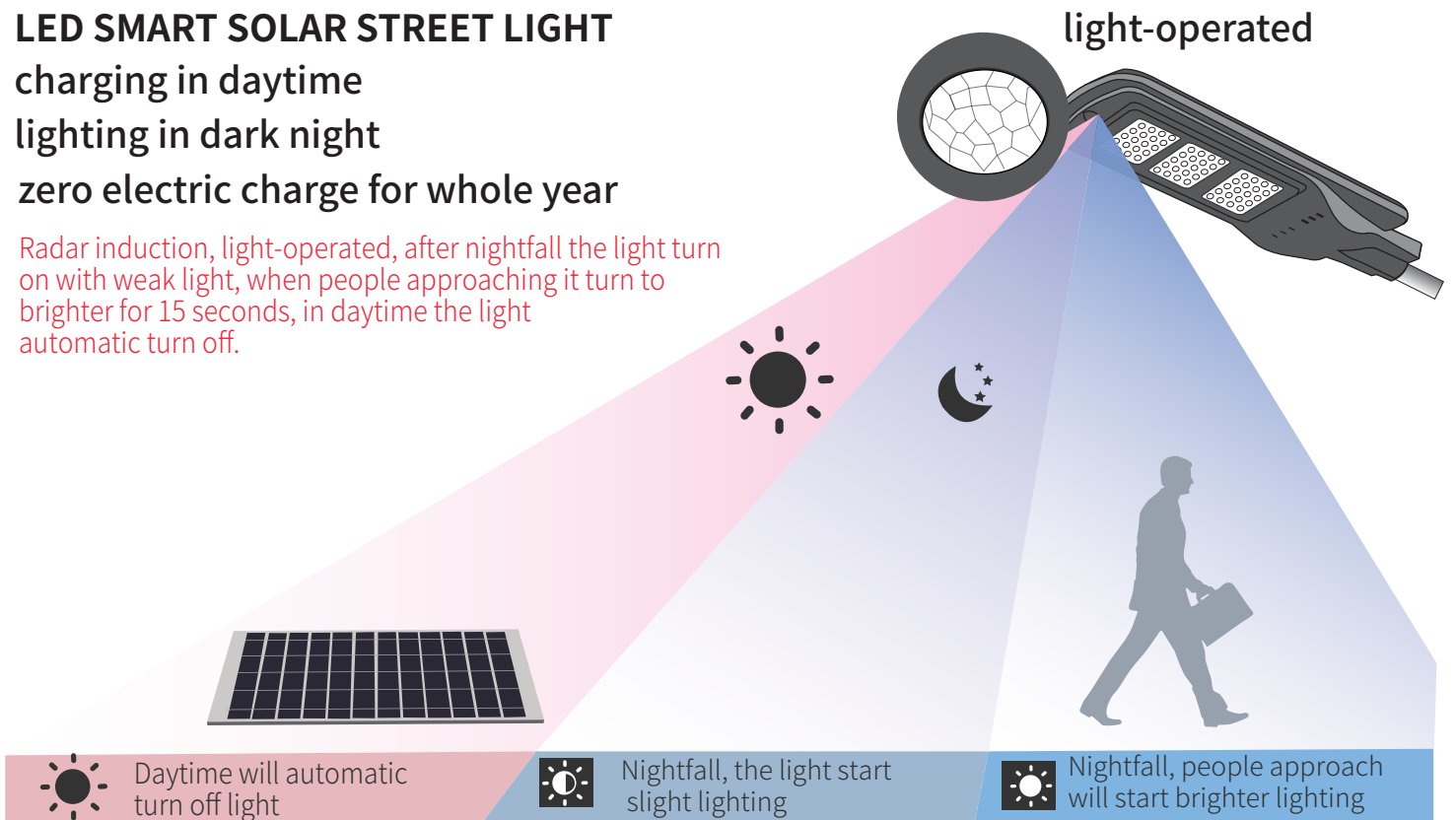

working principle

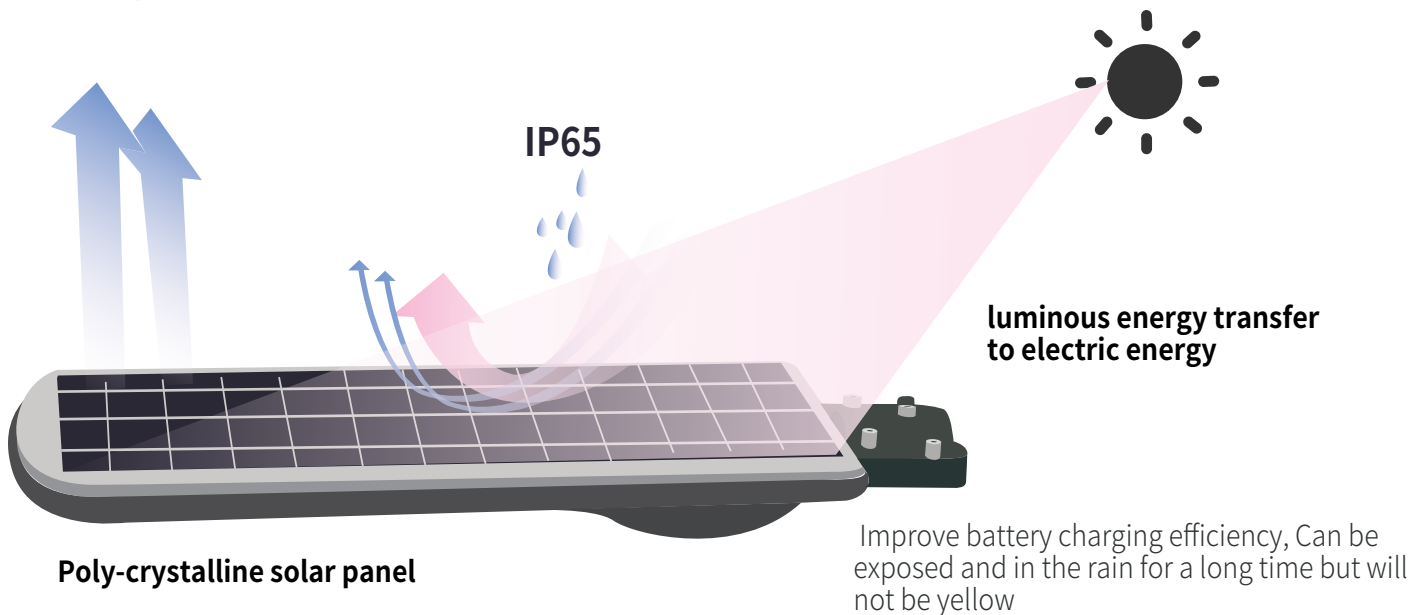

Charging time: 6-8 hours

**Working time:
Under full power can work 40 hours**

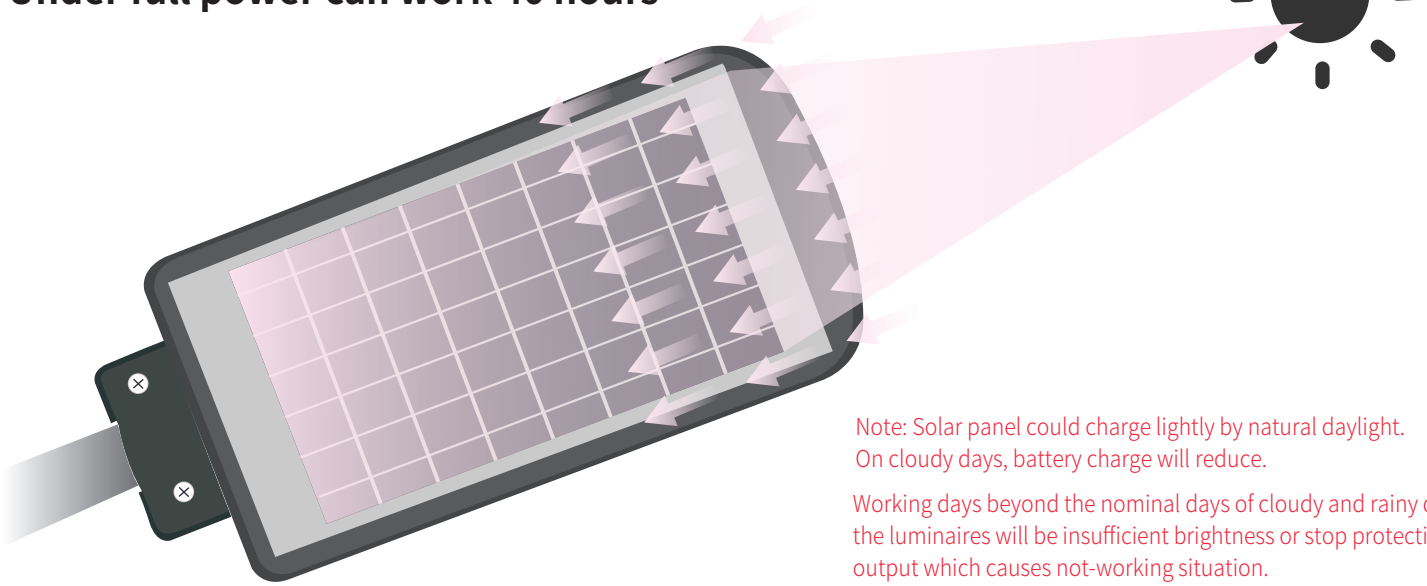

Note: Solar panel could charge lightly by natural daylight. On cloudy days, battery charge will reduce.

Working days beyond the nominal days of cloudy and rainy days, the luminaires will be insufficient brightness or stop protecting output which causes not-working situation.

It will be back to normal after charging in sufficient sunlight

▶ Large capacity battery

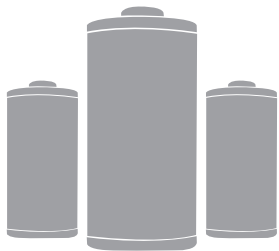

UN38.3
Transportation Safety
Certification

MSDS
Material Safety Data Sheet

Model number	Battery type	Milliamp
LD001-20W	Lithium iron phosphate	3.2V /8000mAH
LD001-40W	Lithium iron phosphate	3.2V /10000mAH
LD001-60W	Lithium iron phosphate	3.2V /15000mAH

▶ Installation method

High-pole installation and Wall installation,
save much money and worries

Usage: Campus, city square, Garden, Road, village etc

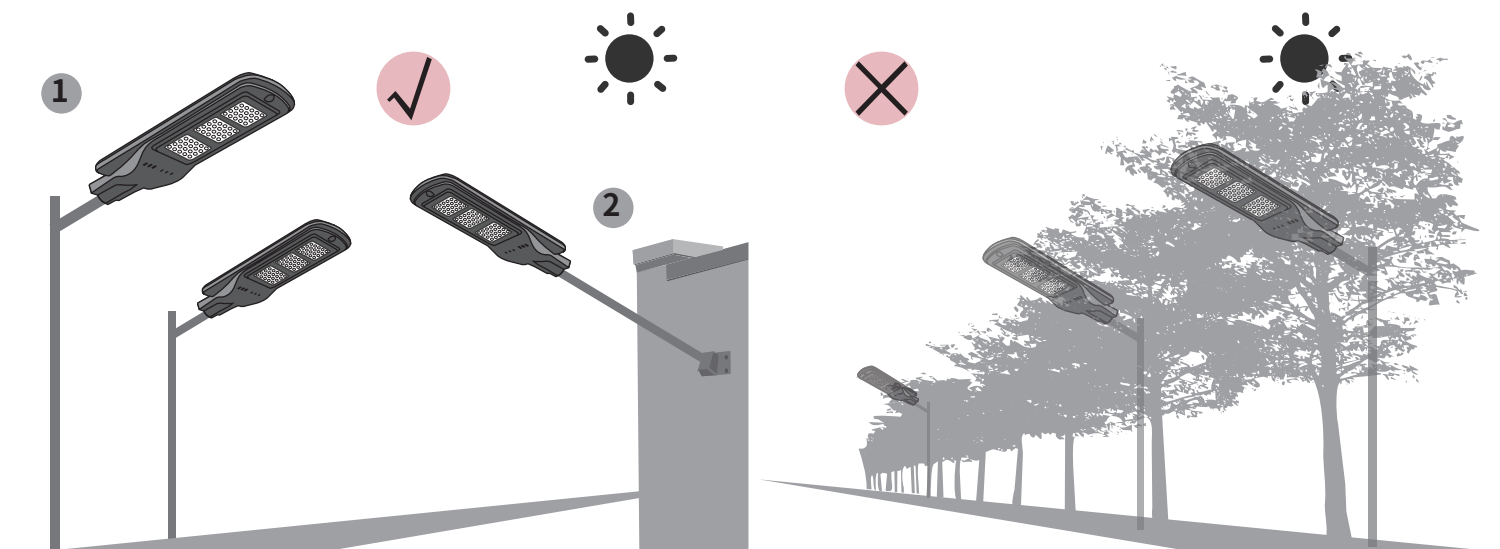

Note: the installation place should be in open area (no trees or buildings sheltering the solar panel)

▶ Light Distribution Curve (Unit:cd) and Lux distance Curve

20W

LD0001-20W
POWER:20W
CIR(RA): 80
WARRANTY: 3YEARS

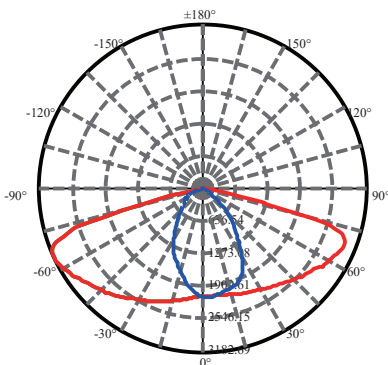

40W

LD0001-40W
POWER:40W
CIR(RA): 80
WARRANTY: 3YEARS

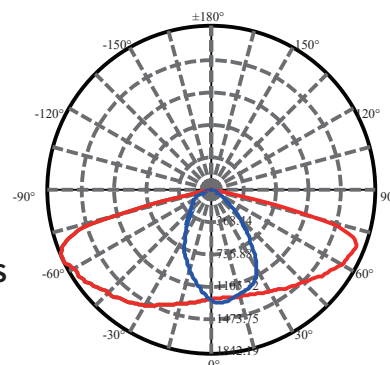

60W

LD0001-60W
POWER:60W
CIR(RA): 80
WARRANTY: 3YEARS

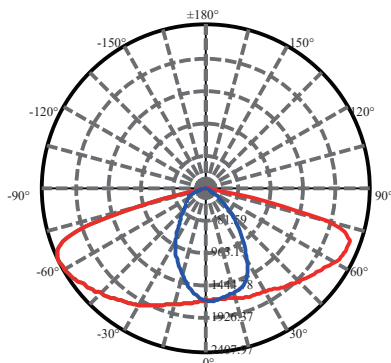

▶ Packing

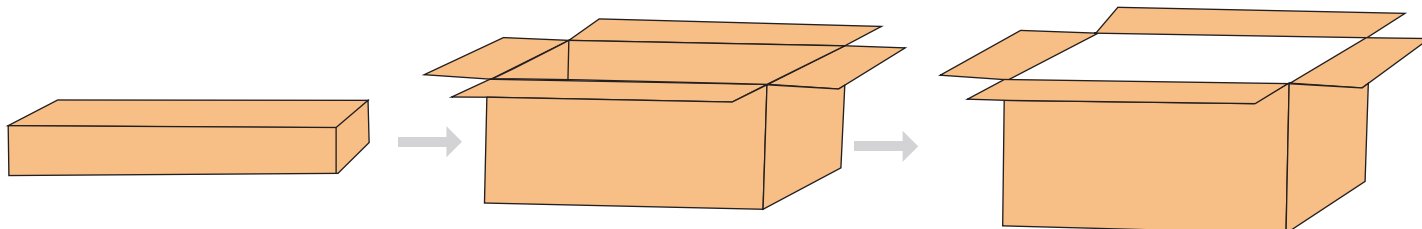

Box

Carton

Packing

Model number	Power (w)	Packing size(mm)	Carton size(mm)	QTY/Carton
LD001-20W	20W	213×63×398	645×440×413	20
LD001-40W	40W	243×73×508	500×380×523	10
LD001-60W	60W	263×73×638	540×380×653	10